

3000

SPECIFICATION

MODEL NO.	HYD/S-2000100
CAPACITY	2000TON
STROKE	100mm
WEIGHT	about 930Kg

2000Ton*100St

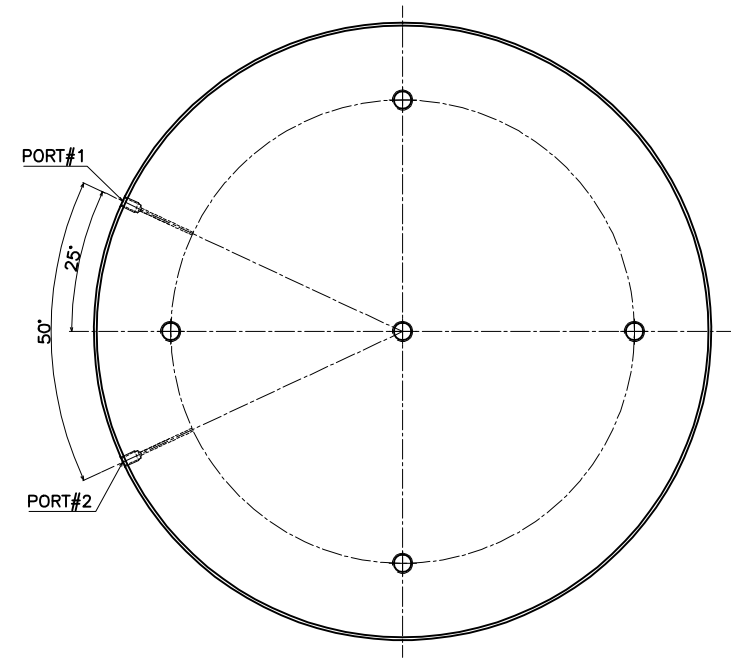
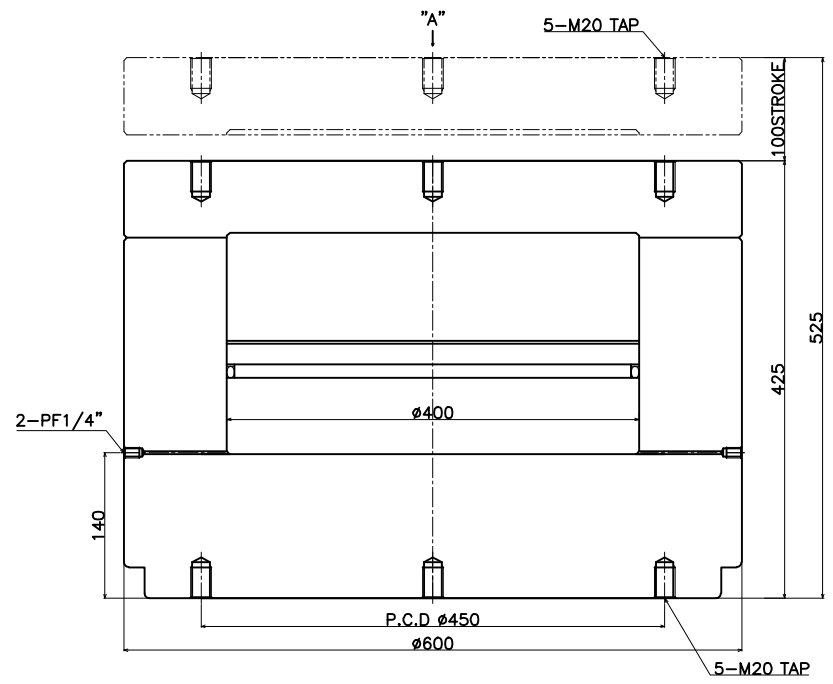

VIEW "A"

전진	
MAXIMUM PRESSURE	2000Kgf/cm ²
WORKING PRESSURE	1500Kgf/cm ²
사용유 : 유압작동유 ISO46	

C.I.K.

ITEM No.